

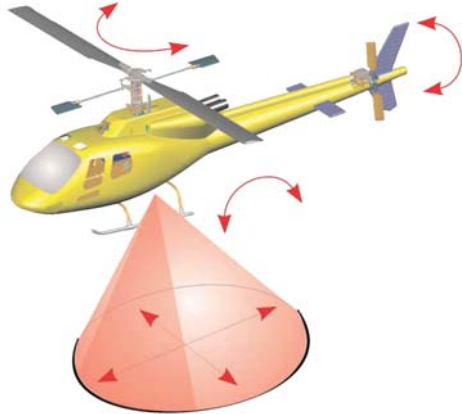





HeliCommand

3A 3D Rigid



 **INSTRUCTIONS**
Version 1.6

    ▶ www.robbe.com



2-3

Congratulations on your decision to purchase a *HeliCommand*.

No other commercially produced system for model helicopters can stabilise the horizontal flight position in addition to the horizontal attitude.

The *HeliCommand* was originally developed from a professional auto-pilot system for commercial helicopters employed in filming and surveying, and is based on several innovative technologies (international patents pending).

The range of potential applications covers beginners and advanced pilots. However, beginners should be familiar with their model's functions, even if they are not yet able to maintain a stable flight attitude when flying. It is ideal for advanced pilots who are expanding their flying skills and wish to practise flying with reduced stabilisation, as well as pro-standard pilots who wish to concentrate entirely on the important functions of their flight display.

If you are a beginner, the *HeliCommand* will enable you to hover the helicopter, carry out slow circuits and generally practise more easily. However, one point which should be addressed here is that the pilot must be attentive, and should not let this unique system seduce him into trying manoeuvres which could endanger himself or others.

To anyone who categorically shuns all electronic aids for helicopter flying, we have this to say: please be reassured: the *HeliCommand* was not developed with the aim of replacing flight tutors and training procedures; its sole purpose is to help modellers learn to fly safely, and to promote safer flying.

HeliCommand 3A No. 8493

- Stabilises all horizontal control movements: inclination (tilt), speed, position
- Auxiliary „pilot“ channel for adjusting stabilisation effect and switching between horizontal mode and position mode
- Integral heading-lock gyro, swashplate mixer and automatic trim
- Second auxiliary channel („AUX channel“) for gyro gain and mode (normal/heading lock); optionally for automatic trim.
- Can be configured without connection to a PC by simple learning procedure, for almost all rotor head linkage types with up to 3 servos
- Fail-safe if radio link fails (PPM / FM only): switches to position stabilisation, collective pitch to 'hold'.
- Suitable for internal-combustion and electric-powered helicopters
- Can be used indoors and in the open air
- PC adaptor available as accessory for supplementary settings, including: setup as necessary for HR4-linkage, automatic trim option, freewheel function for forward flight, optimised settings for stabilisation and tail rotor gyro.

HeliCommand 3D No. 8494

- Includes all the features of the basic „3A“ version, plus:
- Horizontal stabilisation for inverted flying
- Expanded set-up facilities via PC adaptor (No. 84942000) (additional Expert settings for optimising 3D mode and control characteristics).

HeliCommand RIGID No. 8495

- Includes all the features of the HeliCommand 3A and 3D, plus:
- **RIGID** mode for stabilising flybar-less rotor heads, highly effective in preventing ballooning and tuck-under at high speed and in gusty conditions.
- Eliminates the need for aileron (roll-axis) and elevator (pitch-axis) trim functions.
- **RIGID** mode stabilises flybar-less helicopters (two or more rotor blades) as well as conventional flybar-equipped helicopters.
- The pilot channel can be used to select: horizontal mode, position mode, **RIGID** mode.
- **RIGID** and horizontal modes even function without visual contact between the optical sensor and the ground, i.e. no opening is required in the helicopter fuselage if you do not need to use position mode.
- Electronic linearisation to compensate for mechanical irregularities (angular offset) when using the H4 swashplate linkage.
- The PC adaptor (No. 84942000) is required for setting Rigid mode. Without the PC adaptor the HeliCommand 3D makes use of the parameters which are pre-set at the factory.

Index

LED Display	8	Tips for flying	32
Description of facilities	9	Take-off and landing	32
Pilot channel	10	Hovering	32
Tail rotor gyro	11	Control travels	32
Automatic trim	12	Effect of the opto-sensor	33
Fail-safe	12	In darkness, or when overflying optically smooth surfaces	33
The upgrade versions of <i>HeliCommand</i>	13	Indoor flying	33
Brief instructions - the essentials	14	Checking the contrast	33
Installation	16	Versions and applications	34
Electrical earth	17	<i>HeliCommand 3A</i>	34
On-board location	17	<i>HeliCommand 3D</i> and above	34
Mounting the unit on the tail boom	18	3D manoeuvres	34
Notes regarding internal combustion engines	19	<i>HeliCommand RIGID</i>	34
Setting up	22	Notes	35
Electric-powered helicopter	22	For skilful pilots: differences in handling	35
Factory reset	22	Range of applications	35
Setting up the transmitter	22	Safety measures / We recommend	36
Calibrating (learning) the transmitter neutral points	22	Liability exclusion / Guarantee	37
Configuring the <i>HeliCommand</i>	23	Fault-finding	38
Setting up the <i>HeliCommand RIGID</i>	26	Specification / Set contents	40
First flight	28	Accessories / Service / Imprint	41
Test-flying	28		
Internal-combustion helicopters: vibration test	28		
Trimming	30		

LED Display

Power up: Power up phase, please don't move for 10 s;
 ● ● ● still no output of servo-signals.

Normal operation: Color indicates the pilot channel position

- Off / conventional controls (glowing red)
- Horizontal mode (glowing orange-yellow)
- Position mode (glowing green)

— Flickering green: not enough contrast, only horizontal mode but no position mode.
For checking: switch to 'green' mode and hold helicopter in different distances above ground by hand.

● ● ● ● ● ● Trim button is pressed, and connect to AUX-Kanal and assigned (via PC-adaptor)

Setup:

- Complete neutral positions learning (then power off)
- Setup process (step number = count of flashing)

Fault at selftest (LED flashes red) No output of servo-signals

- (1x) No R/C-receiving (during selftest)
- (2x) Battery < 4V power up (Do not use for charge monitoring!)
- (3x) Movement during power up phase, please repeat (or if necessary wait for temperature change to settle)
- (4x) Instruments fault or too extreme temperature or need new factory calibration after severe stress or ageing
- (5x) Auto trim value at the limit must be cleared and adjusted mechanically
- (6x) (reserved)
- (7x) unacceptable center divergence at automatic learning process; at least one channel out of center?
- (8x) No R/C receiving at automatic learning process

— LED dark : undervoltage < 4V

Description of facilities

Basically, all versions (3A, 3D, Rigid) offers the following modes of operation:
 LED red =stabilising functions switched off (= conventional)
 LED yellow = horizontal mode
 LED green =position mode

Horizontal mode („yellow“): moves the helicopter to the horizontal attitude if you release the aileron (roll-axis) and elevator (pitch-axis) controls. This works totally independently of the optical quality of the ground surface. For indoor flying you should select this mode; if you do not wish to, please read the notes on page 29.

Position mode („green“): in this mode the unit stabilises the model's position as well as its horizontal attitude. This is the most powerful stabilisation, and is ideal for "automatic" hovering and slow circuits. It works most effectively at heights of about 0.5 to 2 metres above a natural surface (grass, gravel etc.). If you release the aileron and elevator controls, the system actively brakes the helicopter until it is stationary; all the pilot has to control is the collective pitch / throttle function. If the model exhibits any slow drift at the hover, this can very easily be corrected manually. For slow circuits close to the ground, you can set a forward speed by keeping a slight constant push on the elevator stick, then direct the model using the tail rotor stick (just like steering a car).

For higher speed and for flying at heights above about 5 m, this mode would tend to be a nuisance because of its corrective actions; in this case you should switch to horizontal mode („yellow“).

The configuration for the above-described functions is possible without PC, unless four head-servos are used.

RIGID mode: this is a fourth mode of operation only available with the *HeliCommand RIGID*: it is designed for flybar-less rotor heads, stabilising and maintaining the helicopter's attitude (see page 5).

Rigid mode can be combined to working parallel with the three modes described above. These options are explained on page 26.

In addition to the previously described stabilising functions, all *HeliCommand* versions offer the following supplementary functions:
swashplate mixer, tail rotor gyro and automatic trim.

10-11

Pilot channel

We recommend that you use this auxiliary channel as it enables you to switch between the three modes, and also to set the desired stabilisation power. It is advisable to use a slider or a three-position switch with selectable output values for the pilot channel. The gain (sensitivity) must be adjusted to suit the model.

If the pilot channel is not connected to the receiver, a pre-set value applies which is: position mode with a setting of +70%; this is a suitable setting for many models, and can be changed to any value you like using the PC adaptor.

slider position signal %	LED-color	stabiliser-effect	sensitivity
+ 100 % (Futaba = -100)		POSITION MODE unsuitable for flying and inverted flying!	100
0 % 1,5ms		OFF (normal hand control)	50
- 100 % (Futaba = +100)		HORIZONTAL MODE <i>HeliCommand 3D</i> and <i>RIGID</i> : Also for inverted flying	100

Slider more towards the center reduces the sensitivity and slows down the corrections.

Additionally, the auto pilot can be overridden by smaller stick deflections.

You may of course exchange up with down side, by reversing transmitter setting or slider mounting.

Tail rotor gyro

The *HeliCommand* features an integral gyro with piezo sensor, which can be operated in either normal or heading-lock mode. A second auxiliary channel ("AUX channel") is used to adjust the gain setting, and to switch between heading-lock and normal mode.

If the AUX channel is not connected to the receiver, the internal default setting applies. This is heading hold mode set to about +65%; it can be adjusted using the PC adaptor.

If you detect a tendency for the helicopter to oscillate (tail swings to and fro), use a faster tail rotor servo, or reduce the gyro gain using the AUX channel or PC. The gyro is suitable for use with high-speed digital servos.

Further adjustments can be made using the PC adaptor, e.g. travel limiting and collective pitch > tail rotor mixing; the latter is mixed in after the gyro, and therefore also works in heading lock mode.

The versions *3D* and *Rigid* provide additional „expert“ adjustments e.g. delay and "hold"- range".

If you do not wish to use the integral gyro, an external gyro can be connected directly to the receiver. In this case please note the following points:

1. Yaw turn rates above 400° / sec. are not allowed, since they might seriously disturb the stabilisation system.
2. If you subsequently decide to use the internal gyro, you must first erase any internal auto-trim values, and check the sensor direction of the gyro.

Automatic trim

This is recommended, but is not absolutely essential. Auto-trim works independently of the auto-pilot, and makes life considerably easier for beginner and pilot alike. To use it, your transmitter needs a momentary (self-centring) button or a toggle switch, assigned to an auxiliary channel. Many transmitters feature a Trainer switch which can be re-programmed for this purpose. The AUX channel has to be configured as the trim function using a PC. When the model is flying, a brief button-press is sufficient to record the trims automatically for aileron, elevator and rudder (tail rotor). The settings are stored in the unit, but can be revised at any time. The automatic trim function requires around eight seconds of steady hovering in order to record the correct trim values; they can then be called up immediately by pressing the trim button. Automatic trim can also improve the performance of the integral tail rotor gyro if the neutral pitch angle of the tail rotor blades is not adjusted properly. Independently of this, the tail gyro has once to be adjusted manually, see page 30!

To activate auto-trim, the AUX channel has to be configured as the trim input using the PC adaptor. The trim is then triggered by switching the AUX signal to +100% (> approx. 60%) (note that in Futaba transmitters „-100%“ means „+100%“ and vice versa).

The LED flickers red to indicate while auto-trim is being sent.

The AUX-channel, if assigned to auto trim, will still switch off the heading-hold-mode by a negative signal -100% (< -60%), but Gyro sensitivity has to be set by PC only. Thus a gyro-mode-switch can be combined into the same channel (e.g. by flight state programming). If you wish heading-hold, then the AUX channel must not send a negative signal; the trim switch should only switch between zero and +100% (Futaba = -100%). Note that the trim channel must not be assigned to any other transmitter control actions which you may have programmed, as you might then trigger auto-trim accidentally. The trim switch should only be operated with the model in flight (unlike the SET-button).

For erasing the internal auto-trim values:

call up the set-up mode (page 23), and then switch on again.

Fail-safe

If you are using an FM / PPM system, the auto-pilot immediately responds to a radio link failure by carrying out the following actions: aileron, elevator, tail rotor to neutral, collective pitch to the last received position, stabilisation to position mode, set to 65%. Fail-safe is not capable of eliminating all radio interferences. For optimum security we recommend the use of PCM systems.

The upgrade versions of HeliCommand

HeliCommand 3D

This version stabilises both the normal flight attitude and the inverted flight attitude. (In inverted flight this is limited to horizontal stabilisation („yellow“), because position holding („green“) requires a visual link between the CCD sensor and the ground.

Even so, this is sufficient to make inverted hovering and aerobatics very much easier.) Adjustments are done the same way as with the HeliCommand 3A. More adjustments are optionally available via PC.

The system does include optical interference suppression for situations where the CCD sensor is directed towards the sky, but for safety's sake the stabilisation mode should always be switched from „green“ to „yellow“ before you start a session of aerobatics or inverted flight.

This is particularly important for indoor flying, but also for high-speed circuits and flying at fairly high altitudes.

Additional important notes: see „Tips on flying“, page 32

HeliCommand RIGID

If your rotor head has no flybar, you must use the *HeliCommand RIGID*, and you must activate *RIGID* mode.

If not, you might find that hovering works properly, but the danger is of increased turning rates which could overload an internal sensor, with risk of serious problems in the stabilisation system!

All the *RIGID*-Mode set-up functions can be accessed using the PC adaptor; they are explained in detail in the *HeliCommand* set-up software; once you have selected *HeliCommand RIGID* as the device type. If you do not change the set-up using the PC adaptor, the *HeliCommand RIGID* behaves exactly like the *HeliCommand 3D* (page 27).

HeliCommand Profi

The professional version of the *HeliCommand* is designed for particularly valuable model helicopters as well as for industrial helicopters and commercial applications such as filming, still photography, surveying etc. It is designed for maximum possible precision, and features important supplementary airborne instruments and other features including auxiliary optics for redundant drift detection, greater flight altitudes and altitude stabilisation.

For more information please visit: www.helicommand.com

Brief instructions - the essentials

The unit is as simple as we could make it in terms of setting-up and flying. However, if you are a beginner to helicopters it is really essential to ask a friend with experience of flying these machines to help you at the initial test-flying stage, as the functions of a helicopter are very complex.

This double page and all the points marked with an exclamation mark  are particularly important, and should be read carefully even by pro-standard pilots.

Installation

- An electrical connection must be created as an earth between the tail boom, the motor crankcase and the helicopter chassis.
- The higher in the model the unit is installed, the smoother the stabilisation in position mode when close to the ground, and the larger the gain setting you can safely use.
- Please ensure that the unit is set vertically, securely fixed in the model, and with an absolutely unobstructed view between the sensor and the ground.
- Important notes for internal-combustion helicopters and comprehensive installation tips: see page 19.

Transmitter

All the mixer functions for elevator, aileron and tail rotor must be disabled: always set single-servo (H1) mode, as the *HeliCommand* is designed to use its own internal mixer exclusively.

Configuration

The unit must be configured in order to match it to the model and the RC system; this only needs to be carried out once (page 23). If the standard default settings suit your model and RC system (page 22) this setup can be omitted.



Before the first flight with the system it is essential to check the control directions and the sensor directions on all three axes! (page 28)

Switching on

When the *HeliCommand* is switched on, it carries out a self-test (LED flashes 8 x).

During this period the helicopter must be standing horizontal and must be left untouched.

LED flashes red continuously: error message (page 8)

Take-off

Don't take the model off before the servos are responding to the controls! It is important to check the controls because the throttle servo or speed controller would respond to the transmitter even if all the other servos were not yet receiving a signal; this might be because the self-test is still running, or because an error has been detected.

Flying

Please observe the safety measures (page 36) at all times. In particular, never take your eyes off the helicopter in the air even when position mode is switched on, as occasional drift or interference influences may occur at any time without warning.

- Indoor flying: please be sure to read the notes on page 33
- Do not fly inverted or attempt aerobatics (3D) with the 3A version; see page 34
- Models without a flybar can only be stabilised using the *RIGID* version, and only then if *RIGID* mode is activated; see page 34
- Even though the system incorporates integral fail-safe and stabilisation circuits, it is not capable of avoiding all crashes caused by radio interference, other transmitters etc. We recommend that you use a PCM system, and check the aerial deployment in the model very carefully.
- Severe stress, vibration and ageing will eventually take their toll on system accuracy, and may require a readjustment of the internal calibrations and temperature compensation values if good precision is to be maintained. This work can be carried out by any Robbe Service Centre.

Installation

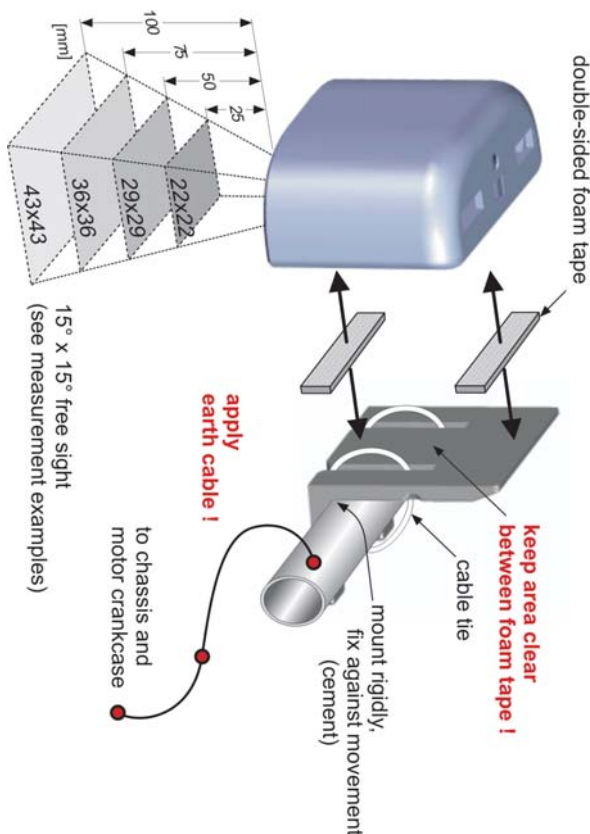
**Electrical earth** !

An electrical connection must be created as an earth between the tail boom, the motor crankcase and the helicopter chassis. Note that carbon is a conductive material. Belt drives inside the tail boom are particularly dangerous, as they act as a high voltage generator. If you ignore this, cables running along the tail boom may conduct sparks (which have already caused servos - not the *HeliCommand* itself- to run to one end-point).

On-board location !

The higher the installation in the model, the smoother the stabilisation effect in position mode at very low altitude, and the larger the gain setting you can safely use. In many models a suitable location is one side of the tail rotor servo, or - using the mounting bracket supplied - the tail boom, the tail rotor servo, the chassis or the fuselage nose. The mounting surface should be solid and should not "give", as this could generate resonance effects.

Installed attitude !

Vertical, with sensor facing down.
Any of the four possible directions can be used.

Unobstructed view between the sensor and the ground

The cross-section of the vision cone is square, with an open angle of 15° x 15°. For this reason you must arrange an unobstructed square vertically below the sensor, with at least the side length
 $S = \text{window size (15mm)} + [0,28 \cdot \text{distance from window}]$
 (see drawing).

It is important that neither the aerial wire nor anything else can get in the way of the vision beam!

Installation in an enclosed fuselage

Cut an opening in the fuselage (see above for size); alternatively do not cut a hole (no sensor view), and manage without position mode. In this case cover the sensor window with dark adhesive tape. If you do this, you can only exploit horizontal mode, and not position mode.

Mounting the unit on the tail rotor servo

Especially with small models, it makes sense to install the unit as high as possible in order to obtain maximum ground distance. This means: as close as possible under the flybar, with a safety margin for maximum flybar travel. The mounting bracket supplied can often be fixed to the top of the tail rotor servo or some other support. Do not use foam under the bracket, fix the bracket rigidly. Alternatively stick the *HeliCommand* to the tail rotor servo case (with foam tape) without using the mounting bracket.

Mounting the unit on the tail boom

Fix the supplied mounting bracket to the tail boom using a cable tie, pulling it really tight. The *HeliCommand* can then be fixed to the bracket by applying two strips of double-sided foam tape to the back of the unit. Once test-flying is complete, secure it against rotation relative to the boom, using UHU-hart or cyano-acrylate glue. Double-sided foam tape is too soft for this purpose.

Protect from vibration !

Please take particular care to protect the unit from vibration!
Use soft self-adhesive foam tape, but don't apply it to the whole of the surface; instead just stick two very narrow strips right at the top and bottom edges of the back panel. This means that the mounting surface must be at least as tall as the *HeliCommand* itself.

Ensure that the *HeliCommand* cannot shift or come loose, as this could cause the model to take up an inclined attitude in stabilisation mode, rendering it uncontrollable.

Remove all traces of oil residue before sticking the unit in place.
We recommend that you wrap a thin rubber band round the *HeliCommand* to guard against the risk of the self-adhesive foam tape coming loose.

Horizontal attitude

Set the unit as close to vertical as possible, i.e. parallel to the main rotor shaft! The electronic compensation means that an angled installation would only be noticeable when the pilot gives a tail rotor command. Miniature helicopters with particularly large blade pitch angles invariably hover with a more pronounced tilt; this is necessary to counter-act for the greater tail rotor thrust. You can compensate for this tilt using the PC adaptor, or see the page 38: „fault-finding“.

Notes regarding internal combustion engines !

- The unit must be installed as far from the exhaust as possible.
- Effective vibration protection is very important, as invisible vibration from the engine can be a particular problem. If you can feel the *HeliCommand* unit vibrating when the engine is running -even though it is installed as directed- we recommend additional vibration damping measures. Velcro (hook-and-loop) tape behind the cell foam is often a suitable solution. The safest option is a metal plate (3 mm aluminium or 1.5 mm steel) which is first stuck to the *HeliCommand*; the foam strips are then applied between this plate and the mounting surface. Additionally secure the *HeliCommand* with thin rubber band. Alternatively you could consider installing the unit in a different location, where vibration is not so severe.
- Avoid running the motor unnecessarily rich, to avoid clouds of smoke confusing the sensor.
- To prevent soiling we recommend that you install a protective tube, or (better) a cubic box under the sensor. Its internal dimensions must take the vision cone into account. Be sure to clean the window regularly right to the edges.

Connections

All modern radio control systems include helicopter mixers which ensure that the servos move as required, for example, the superimposed servo movements required for a three-point swashplate linkage.

However, when the *HeliCommand* is used, the mixing must be carried out using the unit's integral mixer. For this reason please select an unmixed helicopter program ("H1" / single servo) at your transmitter, so that only one servo moves when you move any transmitter stick in any single plane. Once this is the case, you can start connecting the system. If you are not sure how to set up the radio control system, please ask the transmitter manufacturer. Alternatively - if a throttle curve is not required - select a standard (base) program instead of a helicopter program. This also guarantees that the signals from the auxiliary channel sliders and switches are also transferred without any mixing.

Attention: if using an H4 swashplate linkage, the PC adaptor is necessary.

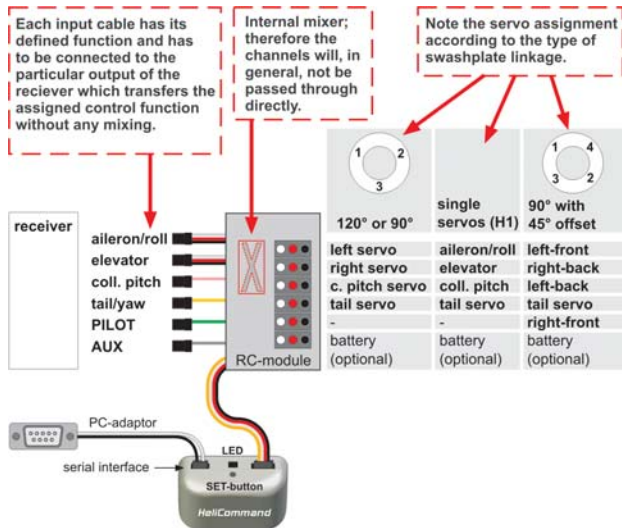

- The RC module (with cable distributor) supplied in the set must be connected between the receiver and the servos. It can be attached to the receiver using Velcro or double-sided tape.
- For extended cable length to the main unit, a ferrite ring is required with at least 3 loops close to the processor board side.
- You must connect at least the aileron, elevator and collective pitch inputs to the receiver.
- The PILOT and AUX connections are optional. Connect these cables to the receiver output sockets to which the associated transmitter controls (sliders or switches) of your RC system are assigned.
- The *HeliCommand* switches itself on when you switch the receiver on.
- Unused input cables can be stowed away by turning them through 180° and connecting them to unused sockets on the receiver or the RC module.
- Cover the vacant socket on the *HeliCommand* with adhesive tape to prevent soiling.
- LED and sockets are internally supported softly and must remain free to move in all directions.

22-23

Setting up

When you have installed the system, or made changes at the transmitter, the *HeliCommand* must be set up (only once) to match the model and transmitter, unless you wish to leave everything at the default settings: e.g. Robbe-Futaba transmitter, Spirit LI model helicopter, or a similar type with the same servo directions and with round side of *HeliCommand* facing to the right.

Important: it is essential to check the sensors and the control directions before flying the model for the first time (page 28)!

Optional set-up facilities:

- Using the SET button: as described below, for (almost) all swashplate types up to 3 servos.
- Using the PC adaptor: in this case only steps A to D-step1 are required. Then see the set-up software, begin with reading the data from *HeliCommand*. This is necessary if you are using an H4 swashplate linkage (or possibly some rare types of swashplate linkage).

Electric-powered helicopter

Be sure to disconnect the drive motor or motors to prevent them bursting into life accidentally; alternatively connect the receiver to a separate battery!

A) Factory reset

This resets the unit to the factory default state; it erases all settings, including those which are only accessible using the PC adaptor. Switch on the *HeliCommand* with the SET button pressed in, then hold the button pressed in a second time for at least five seconds until the LED flashes red-green alternating.

B) Setting up the transmitter

All swashplate mixer functions must be switched off permanently. Set the elevator and aileron travels at the transmitter to around 100%. Values for Expo can be set. Transmitters with 1.6 ms norm (Multiplex) must be set to the UNI mode (1.5 ms). If the integral heading-hold gyro is used, all tail rotor mixers must be switched off at the transmitter.

C) Calibrating (learning) the transmitter neutral points

- Set the transmitter sticks to neutral, collective pitch to minimum, trims to neutral, or - if you have already test-flown the helicopter using the *HeliCommand* and only small trim values are set - leave the trims where set.
- Hold the SET button pressed in for one second until the LED glows green, then release it again and switch off. Job done. (If the LED becomes red: p. 8)

The calibration process can be repeated at any time. The *HeliCommand* now "knows" the signals which correspond to the "neutral and stationary" command. For this reason the calibration must always be repeated if you move the transmitter trims substantially. The trim itself is not influenced by the calibration process. For this reason please leave the trims alone once the unit has "learned" the settings; you will only need to correct them if you make changes to the unit's internal mixer. When using the auto-trim option, the transmitter's trims must never be used; you can just leave the elevator and aileron trims at neutral.

D) Configuring the *HeliCommand*

The helicopter's mechanical systems (neutral position of swashplate and tail rotor) must be adjusted at least approximately (fine trim follows afterwards). The calibration process can only work properly if the input cables and servos are correctly connected, and if any mixer functions at the transmitter are completely disabled. If in doubt, connect any servo directly to receiver in order to insure that each channel only responds to one stick function and to find the proper channel of each function, then reconnect again. You should now simply run through the following steps:

Calling up the set-up mode

Calibrate the transmitter neutral setting (see above „C“), but holding the SET button pressed in for at least three seconds until the LED flashes green. This simultaneously erases the internal auto-trim values. The servos will now not run, or will run differently to normal, according to the stage of the set-up procedure.

Setting up and storing for each step (1-5)

This is carried out using the stick actions described below, combined with a long press on the SET button.

Changing the set-up step

The current step (1 - 5) is indicated by the number of flashes. When you call up set-up mode, step 1 appears first. Press the SET button briefly to move on to the next step without changing the setting; this also takes you back from step 5 to step 1. You can repeat the settings as often as you like using this method. However, for the initial set-up procedure please run through all the steps in turn, as described below.

Close set-up mode

This is possible at any time simply by switching the system off.

The set-up steps

1) Learning the stick direction

- In set-up mode the LED will flash green at regular intervals. Check that any electric power system is disconnected.
- Hold SET button pressed in, and move the transmitter controls to their full travel (in any order) with the button pressed in: Right-aileron, elevator forward (push), right yaw (tail rotor stick), then neutral again; collective pitch maximum and leave it there. Now release the button. From this point on you must not change the direction of any channel at the transmitter (apart from deliberately reversing collective pitch).

2) Servo direction(s) "collective pitch" (and recognizing linkage type)

The LED must flash twice (press SET button briefly if necessary to move on to the appropriate step). If you now increase the collective pitch stick setting, the swashplate should rise evenly, without tilting. You can now select the right one from the ten possible options, working forward or back by moving the aileron stick to either side. Store the correct setting with a long press on the SET button (> 1 second until LED flashes 3 times).

3) Servo directions „elevator“ (+ „aileron“)

The LED must flash three times (press SET button briefly if necessary). The elevator stick should now tilt the swashplate evenly, without changing its height. You can now select the right one from the two or eight possible options, working forward or back by moving the aileron stick to either side. For single servo linkage type only: choose amongst the 2 possibilities using right roll stick movements only. If additionally the aileron (roll) direction has to be changed, hold the aileron stick to the left for a longer time (1.5 s) and test with left stick movements. (available only with HeliCommand versions carrying a two-figure code on the label, left of the part No.) With other linkage types, the direction of aileron travel should automatically be correct after storing; otherwise the servo connections are swapped over, or the aileron or pitch stick direction have been "learned" incorrectly; in that case repeat the procedure). Store the setting with a long press on the SET button (>1 second until LED flashes four times). Now all three directions of swashplate travel should be correct. If the swashplate is not level, adjust the mechanical linkages at this point.

4) Servo direction, "tail rotor"

(If external gyro is used, skip this step.) The LED must flash four times (press SET button briefly if necessary). Select correct direction of tail rotor servo by moving the aileron stick to either side: with tail rotor stick to the right, the nose should move to the right, the tail rotor must "blow" to the right. You can now adjust the tail rotor neutral point, since heading hold is disabled in Step 4. Check the setting, and store it with a long press on the SET button (>1 second).

5a) Installed position (sensor direction) and direction of rotor rotation

The LED must flash five times (press SET button briefly if necessary). The HeliCommand now needs to know its installed orientation, i.e. whether the round side of its housing is facing right, left, forward or back. Program this by moving the aileron or elevator stick towards the appropriate side of the swashplate, then give SET button a long press (>1 second).

5b) Direction of main rotor rotation

In step 5 move tail rotor stick in same direction as the direction of rotation of the main rotor (viewed from above), and store with the SET button (>1 second).

Concluding the setup

Switch on again and check the controls. Set any travel reductions at the transmitter to prevent mechanical fouling, and set the correct collective pitch range (because travels may now be different to those set when you were using the transmitter's mixer). Any major travel reductions should be set in the HeliCommand using the PC adaptor. The swashplate should now be exactly horizontal; if not, adjust it at this stage. Coarse adjustment: there should be a point in the middle of the collective pitch range where all the servo output arms are at neutral simultaneously. If not, unscrew the output arms and replace them in the correct position. For fine-tuning: adjust the pushrods and / or use the transmitter trims, and then use the SET button so that the HeliCommand "learns" them again.

For transmitters featuring multiple flight modes (phases): It is important to have identical trim values for all flight modes while the HeliCommand is activated ! This is particularly important in Rigid mode.

Setting up the HeliCommand RIGID



Before using the system in a flybar-less helicopter please note that it is essential to activate **RIGID** mode (using the PC).

The attitude-maintenance stabilisation ("head gyro") maintains an angle of inclination once set, and prevents the model from ballooning up into wind - to the extent of the helicopter's control system's power to provide the corrective action. You can observe this function at the swashplate, as it will remain in the inclined attitude you have set.

Depending on the setting, some care is required before take-off to ensure that the swashplate is not accidentally set to too great an angle (through slow drift or accidental movement), and that the RIGID gain is not set too high. Unlike usual practice with tail gyros, the gain setting does not need to be set hard up to the limit of oscillation!



The HeliCommand must only be used to control flybar-less helicopters with the **Rigid** mode switched on !! Otherwise there is a risk of generating excessive aileron / elevator rates; this could overload the sensors internally, and this in turn could have a serious adverse effect on the horizontal mode and the position mode!

Scale models often have their swashplate travels mechanically reduced to about half of „conventional“ aileron and elevator travels. When employing the HeliCommand, we recommend to undo the reduction, i.e. increase the mechanical throw in order to achieve optimum stability.

Rigid stabilisation has to be activated using the PC. Please check www.robbe.com/rsc under 'downloads' or www.helicommand.com for the latest software update, after you have done the basic installation.

The available Rigid-options are shown in the drawing:

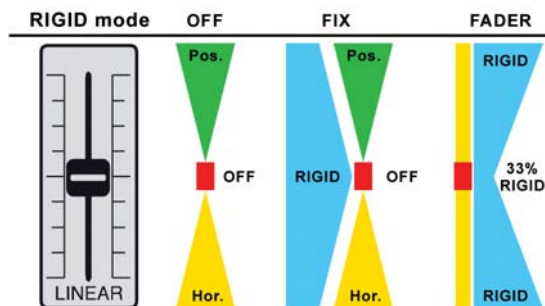

[OFF] mode

This corresponds to HeliCommand 3D. Not suitable for flybar-less helicopters!

[FIX] mode

Activates the RIGID function permanently (in addition to Horizontal and Position mode as defined by Pilot Channel).

Take particular care with the RIGID gain, because you cannot reduce it in this mode during flight using the pilot channel, and excessive values can generate dangerous lurching or oscillating movements. Adjustment here is only available via "sens. gain" setting in the PC (not via the "pilot channel default" setting).

[FADER] mode

Disables Hor. and Pos. mode, so the handling is like a „normal“ helicopter, i.e. a horizontal attitude has to be controlled manually. On both sides of the pilot channel (transmitter slider) only RIGID stabilisation is superimposed symmetrically as far as the maximum value of "RIGID sens. gain", which can be set via PC. Slider end on either side equals the center position of the [FIX] mode! With slider at center point, gain ("head gyro" for elevator and aileron equally) is reduced to 33%. This mode is suitable for finding the optimum RIGID-gain setting. If later you switch to the [FIX] mode, you should reduce the gain setting via PC by the same proportion as found on the pilot slider. (E.g. Rigid-sens-gain (roll)=7, Slider=70%: new Rigid gain=7x70%=4.9, i.e. set to 5).

First flight

Before the first flight you must carry out a check of the sensors and controls for all sensor directions

- Neutral setting, directional sense of all stick and servo movements.
- Pilot channel and (if used) auto-trim button: check by LED. (before checking auto-trim, please set collective pitch to minimum. This prevents the trim channel from doing a (blind) trim action, yet allows the LED to show the autotrim trigger.



- All three sensor directions. Any sensor working in the wrong direction would cause the helicopter to crash. Set the stabilisation to "yellow" mode and briefly move the model to and fro by hand, working around all three primary axes: tilt to the side, tilt forward and rotate. At each movement the appropriate servos must respond with the opposite action: the swashplate should try to remain horizontal, the front faces of the tail rotor blades should move in the opposite direction to the tail swing direction.

- Carry out a range check with the transmitter aerial collapsed.

Test-flying

If you are a beginner, we recommend that you ask a modelling friend with experience of helicopters to check the settings and help you with the first flight. Notes on trimming: see pages 12 + 30

Internal-combustion helicopters: vibration test

Severe vibration or body resonance can cause serious problems with the correct operation of the sensor; three checks are therefore necessary:

- 1) Place your hand on the case of the *HeliCommand* unit and feel whether it is vibrating.
- 2) Before take-off, switch to "yellow" mode and observe whether the swashplate stays level at all rotational speeds.
- 3) Take off initially in "OFF" mode, then switch stabilisation only briefly on and off again, as a first try for safety's sake. If applicable, repeat this at different motor speeds.
If problems occur, please refer to the installation notes on page 16

At take-off

Prior to take-off the helicopter should be standing as level as possible. If you have to hold the helicopter inverted or at a steep angle before flying, switch the *HeliCommand* off, then on again before take-off. (When angled in this way, the gravitational forces are applied perpendicular to the rotor shaft which do not occur in normal flight, and these can have an adverse effect on the operation of the sensors.)

Checking the controls before each flight

Check the controls and the neutral position of the swashplate, and repeat the check with stabilisation switched on. Do not take off before the servos are responding to the commands!

Gain setting

Start the test-flying schedule with a reduced gain setting! Not all helicopters will tolerate settings above 70% in both modes, as severe oscillatory movements may occur, depending on the type and installed height of the unit. This applies in particular when the distance between the sensor and the ground is very small (< 0.5 m). The optimum (slider) position must therefore be tried out during test-flying.

Set the gain so that optimum stabilisation is achieved in the "green" Pos mode at an altitude of about 0.5 m.

If oscillation occurs → reduce. If drifting uncontrolled → increase.

With tail rotor gyros it is usual practice to set the gain hard up against the limit of oscillation, but this is not necessary with the Pilot channel of the *HeliCommand*. "Softer" settings look better in flight, as the model's flight path is affected less directly by the *HeliCommand*'s spontaneous control actions.

If your helicopter is extremely unresponsive or extremely agile, you may find it necessary to optimise the stabilising effect by making use of the supplementary settings which are available via the PC adaptor.



During high-speed flight the *HeliCommand* only brakes the model slowly by itself. This means: if you override the *HeliCommand* by giving powerful control commands (see page 34), you will have to control the helicopter actively. Please note that a variable "forward freewheel" option can be set using the PC adaptor.

30-31

Trimming

If the automatic trim is not used, then it is better to set the trims initially with the stabilisation switched off.

After this, and always when the transmitter trim positions have been changed significantly, the transmitter neutral setting should be re-calibrated using the SET button (see page 22).

In the first few seconds after take-off, the accuracy of the stabilisation system is reduced, but precision automatically increases after about ten seconds of flying.

For this reason, when the Hor- or Pos-mode is active, it is good to wait a little while, rather than setting the trim immediately. In most cases the trim does not need to be readjusted after this.

If the trim is different with and without stabilisation: the transmitter neutral setting needs to be re-calibrated (page 22).

Tail rotor trim (internal gyro)

The transmitter trim slider is only used once, to adjust it to the neutral point of the internal gyro (even when using auto trim). This can be done with the model on ground: While in heading hold mode, trim the transmitter so that the tail servo can be controlled into various holding positions and remains there still without drifting off by itself. (This tail trim is not affected by the SET button; set only calibrates roll and elevator).

If you are not using "auto-trim", we recommend that you additionally trim the tail rotor mechanically with heading-hold switched off, as this will avoid trim value differences when you switch between heading lock and normal. If sensor drift occurs due to temperature fluctuations or after a long period of operation, this can be eliminated by switching the unit on again. (Don't use the automatic trim for this; auto trim only corrects the servo centres.)

Generally we recommend to set the internal REVO mixer (via PC adaptor), this enhances the stability to a large extent.

Note: some common tail gyros automatically adapt their neutral point to the presently received trim position, each time they are switched on. The *HeliCommand* intentionally does not do this; only the sensor-null is re-calibrated each time. (The neutral point is fixed on 1.52 ms). Therefore, the stick position during switch-on is arbitrary; but it is necessary once (for the first flight) to trim manually.

Only in case of rapid temperature change, small trim adjustment may be necessary - or the *HeliCommand* can be forced to readjust itself by switching off and on again.

With automatic trim

Simply press the auto-trim button on the transmitter, regardless of the stabilisation mode you are using. The helicopter only needs to have been in an approximately steady flight state for about eight seconds before you do this. The trim always refers to the transmitter's neutral setting, as calibrated in the *HeliCommand* unit. For this reason it is not possible to adjust the aileron and elevator trim on the transmitter at the same time (in fact, you can tape over the trim sliders!). However, if you do move them, the new values must be "learned" again as the "transmitter neutral setting" (page 22) before you use the auto-trim button on the transmitter again.

Tips for flying

Take-off and landing

You can switch the stabilisation on before take-off or during the flight.
Important: never set the gain higher than the optimum value established during the test-flying schedule.

Hovering

The effect of position mode is strongest when the helicopter is flying close to the ground. At the other extreme, the *HeliCommand* gives you more latitude for free movement at greater altitudes.

If you are a beginner, start by flying at a height of around 0.5 - 1.5 m; in any case this is the easiest altitude at which to learn. If you fly higher and get into difficulties, the safest direction of escape is upwards. Position mode is effective up to a height of around 3 metres in flat calm conditions; up to about 1 m if windy. Horizontal mode is effective in any condition.

The stabilising effect only works properly when the helicopter is flying.

When the machine is standing on the ground with the rotor spinning, it must be controlled manually!

Control travels

The *HeliCommand* can be overridden manually even when gain is set to maximum; it is overridden if you move the aileron or elevator transmitter controls past about 50%. (When you neutralise the aileron and elevator controls, the *HeliCommand* becomes active again immediately.) If you are a beginner we therefore recommend that you control your model with small stick deflections, and set Expo at the transmitter!



If you reduce travel at the transmitter (Dual Rates), this might disable the manual override facility. For safety reasons you must however retain a means of overriding the system, and this can be achieved by reducing the pilot channel at the same time. If your transmitter features multiple flight modes (phases), you can pre-set the pilot channel to different values using flight mode programming. If you wish to reduce control travel permanently, we recommend that you carry out the changes on the *HeliCommand* using the PC adaptor.

During high-speed flight, the *HeliCommand* will only brake the model slowly by itself. This means: if you override the *HeliCommand* by giving powerful control commands, you will have to control the helicopter actively in order to slow it down, i.e. you should not carry out such manoeuvres unless you are confident of the control commands required.

Effect of the opto-sensor

Position mode works entirely without a visible horizon; that is why it also operates properly close to trees etc.

If you are a beginner to helicopters it is best to restrict your flying to normal ground surfaces (grass, gravel etc.) This should ensure that maximum stabilising effect is always available.

In darkness, or when overflying optically smooth surfaces

(water, snow, car roofs, smooth unpatterned indoor floors etc.)

In such cases, i.e. when the optical ground sensor cannot detect sufficient contrast, only horizontal mode will be active even when the unit is set to "green" (position) mode. Brief contrast interruptions are bridged by the intelligent software, and will not be noticed by the pilot. However, if the contrast remains too low for a long period, the remaining instruments automatically take the stabilising role; if this should happen, you will need to keep an eye on the helicopter's position and, if necessary, correct it with slight stick deflections.

If you have to fly under the conditions stated above, for safety's sake you should select "yellow" horizontal mode beforehand. If you are unsure, check the contrast as described below.

Indoor flying

Use "yellow" mode. "Green" mode is taboo unless you check the floor contrast from different distances (see below) and limit yourself to normal flight altitude (in "green" position mode don't fly inverted indoors - even with the *HeliCommand 3D*!).

Checking the contrast

In the "green" position mode the LED will flicker to warn you that the contrast or brightness is not sufficient; this means that the *HeliCommand* has automatically switched to "yellow" horizontal mode. You can check this close to the ground and at various distances above ground.

Also, the sensor's response can be watched, by setting "green" position mode and moving your hand under the *HeliCommand* at a distance of about 30 cm.

Versions and applications

HeliCommand 3A

This basic Version is not suitable for aerobatics and 3D manoeuvres. The *HeliCommand 3D* and *RIGID* are designed specifically for this type of flying!

HeliCommand 3D and above

For brief 3D flying (single turn-around manoeuvres) the "yellow" horizontal mode can be left switched on to provide support. This mode provides stabilisation in normal flight and inverted flight. You can still override the stabilisation manually. The degree of manual control can be varied using the pilot channel, and a wide range of additional adjustment facilities is available using the PC adaptor.

One particular use is for switching between positive and negative hovering. The stabilisation can also be switched on for use as an "emergency knob", but please note the following points in this regard:

3D manoeuvres

For agile 3D manoeuvres with a multitude of subsequently flown rolls, loopings etc, even the *HeliCommand 3D* should be switched to OFF (red) beforehand, and not switched on again until at least 15 - 20 seconds after the manoeuvring has finished.

The same applies to multiple stall-turns, since these may affect the horizontal neutral detection under certain circumstances.

HeliCommand RIGID

Activating *RIGID* mode using the PC adaptor minimises the effects of wind gusts and ballooning when flying into wind or in high speed.

In this mode unrestricted 3D flying and aerobatics are possible, and can be carried out with excellent accuracy.

When you switch on horizontal or position stabilisation, the same applies as stated for the *HeliCommand 3D*; see above.

Notes

- Over tall grass, loose foliage etc. it is always better in the interests of safety to fly fairly high, because objects moving about in the rotor downdraught may adversely affect position mode, or switch to the horizontal "yellow" mode.
- If the model is subject to a rapid change in temperature, please wait for at least five minutes for the system to settle down before you switch on, and do not use the system below -5°C or above +50°C. (If the stabilisation is switched off, it can be used between -10°C and +50°C.) It is best to switch on only just before take-off, and then to leave the helicopter level, i.e. avoid touching it in any way.
- If drift is detectable after a 90° ... 180° tail rotor rotation, the installed attitude in the model can be optimized (see fault-finding).
- Don't use the system in the rain - short circuit hazard!

For skilful pilots: differences in handling

- Switch off the stabilisation before flying stall-turns, because - of course - the system would try to return the helicopter to the horizontal attitude.
- Use "green" position mode only for hovering and for slow flying close to the ground!
- To incline the helicopter at large angles, e.g. in order to brake from high speed, you will need to apply larger control deflections than without stabilisation. For auto-rotation: reduce the gain.
- To fly smooth turns hold the nominal angle of bank with aileron, otherwise the helicopter will try to right itself.

Range of applications

The system is designed to make it easier to control model helicopters as used by hobby pilots.

Caution! Not designed for manned vehicles or for military purposes. Infringement is strictly prohibited; breaches of this rule will be pursued as a licence violation. The modelling versions *HeliCommand 3A*, *3D* and *RIGID* are not suitable for use in built-up areas, close to or above buildings and installations.

For professional applications such as still photography / filming / surveying etc. the *HeliCommand Profi* should always be used. See on page 13.

Safety measures

The terms "auto-pilot" or „stabiliser“ do not mean that the model flies completely automatically!

As with any conventional model helicopter flying, great care and practice are required when using this product.

No auto-pilot is capable of eliminating the dangers of operational errors. It could even be argued that the risks are greater with such an aid, because the ease of control could allow a pilot to become careless, or sway less trained pilots into flying in situations where they cannot regain control if a technical fault should occur.

Technical instruments are liable to failure, and a helicopter fitted with more instruments incorporates more items which could go wrong.

As everyone knows, flight instruments are not immune to problems and failure. In the interests of safety, no pilot should ever rely exclusively on the stabilisation system, and pilots should satisfy all required safety measures at all times.

We recommend

- Always keep your model a safe distance from persons and objects, and fly in a cautious, conscientious manner.
- Do not under-estimate the energy contained in spinning rotor blades. For practice-flying with larger model helicopters we recommend that you fly behind a safety net or football goal, as are present at many model flying sites.
- If you are a beginner, ask a model pilot with experience of helicopters to help and advise you - especially when test-flying a new model or a first installation of the *HeliCommand*.
- Set the stabilisation level to suit the ambient conditions. Always operate the *HeliCommand* in such a way that you can switch it to manual control in flight, or at least in such a way that you can override it in an emergency.
- Always fly at approved model flying sites, well away from residential areas and public roads, and observe legal requirements.
- Keep well clear of radar stations, radio transmitter masts and other potential sources of radio interference.
- Third-party insurance is in most places a basic essential when flying model aircraft.
- Never take your eyes off the helicopter when it is flying.
- If you ever pass on this product, be sure to pass on these warning notes to the new owner.

Liability exclusion

Specialised knowledge and expertise are required in order to install, set up and operate the *HeliCommand* and the helicopter itself. Errors and negligence can result in accidents, which may cause serious personal injury, damage to property or traffic accidents. Since the manufacturer and retailer are unable to ensure that you handle the product correctly and competently, we can do no more than expressly point out these hazards. We deny liability for any damage resulting from the use of our products, from problems in the installed instruments and from failure of the signal transmission link, unless such denial contravenes statutory requirements.

Guarantee

We guarantee this device for a period of 24 months. The till receipt given to you when you purchased the product serves as proof of the start and finish of the guarantee period. Any repairs carried out under guarantee do not extend the guarantee period. During the guarantee period we will correct any functional defects, material faults or production faults at no cost to you. We will not consider additional claims, e.g. for consequent damage. Goods must be sent to us pre-paid; we will pay return carriage. We will not accept packages sent without pre-paid postage. We accept no liability for transport damage or the loss of your shipment; we recommend that you take out suitable insurance to cover this risk.

The following requirements must be fulfilled if your guarantee claim is to be processed:

- You must send the till receipt to us together with the product.
- You must have operated the unit in accordance with the operating instructions.
- You must have used only recommended power sources and genuine robbe accessories.
- There must be no damage present caused by damp, unauthorised intervention, excess voltage, overload or mechanical stress.
- Please include a brief but accurate description of the fault, to help us locate the problem.

Fault-finding

Servos do not move → see page 8 „LED indicators“

Jitter or oscillation in position mode, especially when close to the ground

- Reduce gain of position mode (on PILOT channel or better via PC on „Position sens.gain“)
- Installed position too low?
→ Install as high as possible, see page 17
- Try increase PC-setting of aileron & elevator travel.
- For some slow reacting models, or in rigid mode, it might be necessary to increase setting of „Horizontal sens.gain“ (via PC).

Machine is not stable in position mode, especially at higher altitude

- Sensor window dirty?
→ Protect from exhaust (glow models), clean regularly
- Low-contrast ground surface, e.g. snow, smooth asphalt, water?
→ Switch to horizontal mode
- Trim not "learned" correctly? see page 30
- Increase gain further? → via Pilot channel or PC
- Dense clouds of exhaust gas in the vision beam?
→ Set motor leaner, and install unit further away from the exhaust.
- Aerial wire or other obstacles in the sensor view beam?
(see first paragraph on page 17, "Installation")
- Much loose foliage or tall grass etc., moving in the rotor draught?
→ Switch to horizontal mode.

Flight attitude not steady, in position and in horizontal mode

- Vibration (visible or invisible), or excessive body resonance affecting the case (especially with glow motors)?
→ See Installation > Internal-combustion engines.
- Double-sided foam tape not applied as two narrow horizontal strips?
→ See page 16

Trim discrepancies with and without stabilisation

- After take-off the accuracy of stabilisation increases automatically within a few seconds of flying.
- Transmitter trims moved?
→ Calibrate ("learn") the neutral setting again.
- Severe temperature fluctuations?
→ Leave the unit for about five minutes to acclimatise, then switch on again.
- Severe vibration? → See "Flight attitude not steady" fault

Automatic trim not working accurately

- Have you moved the transmitter trims?
→ See page 30. Either re-calibrate the trim or avoid touching the transmitter trims.
- Pitch-minimum correctly calibrated (SET-button)? → without given pitch, the auto trim is disabled
- Internal tail gyro has not been trimmed for? (→ page 30)

Drift after tail rotor swing

- Unit not installed exactly vertical; lightweight helicopter with high blade pitch angle?
→ Optimise by flying a 90° right-hand turn from the hover, with stabilisation set to "yellow" mode. If the helicopter was stationary before the quarter-pirouette, but always drifts in a particular direction afterwards, then the installed location can be optimised.
If the model drifts at an angle left / forward (relative to the new position), incline the *HeliCommand* further to the left; the reverse applies if it drifts right / rearward.
If the machine drifts right / forward, tilt the *HeliCommand* slightly forward; do the reverse if it drifts left / rearward.

Inverted flight:

- Roll centre deviation when hovering inverted, or after switching back
→ Optimise the setting „neutral tilt compensation“
(using the PC adaptor; see PC set-up software).

Drift after aerobatic manoeuvres (stall-turns, rolls etc.)

- *HeliCommand 3A* in use?
→ Not suitable for inverted flight or steep flight attitudes!
→ upgrade to **3D**.
- External tail rotor gyro in use, and rotational (yaw) rate > 400° / second?
→ Reduce rotational rate (Seite 25)
- Completed a series of full rotations, such as multiple stall-turns, rolls or loops?
→ See notes on page 34!

Tail rotor servo not at centre

- External gyro used recently?
→ Erase auto trim values.

Specification

Operating voltage: 4,8 ... 6 Volt (4 ... 5 NiXx)
Current drain: 55mA (at 5V)
Dimensions: 55 x 35 x 22,5 mm
Weight incl. cables: 33g
Temperature range: -5° ... +50°C; +23° ... +122°F
in „OFF“ mode: -10° ... + 50° C; +14° ... +122°F

Max. allowed turn rates in „hor“- and „pos“-mode:
roll and „nick“ (pitch axis): ≤ 200 °/s
yaw (if external gyro used) : ≤ 400°/s

Swashplate linkage types:
CCPM:
(separate servo functions)
ECCPM:
Tri-Link H3(120°), H3(140°), H3(90°), Four-Link H4(90°), H4 (90+45°)

RC module suitable for use with:
Robbe-Futaba PPM / PCM 1024 / PCM G3 modulation
Graupner/JR PPM 8, PPM 12, SPCM modulation
MPX PPM8, PPM 12 with UNI modulation
And other transmitters with standard 1.5 ms neutral position.

Set contents

- HeliCommand main unit
- RC module (with cable distributor)
- Mounting bracket
- Self-adhesive double-sided foam tape, 2 sets, 2 strips each
- Cable ties
- Instructions



Accessories

- PC adaptor with software CD No. 84942000
- for serial COM-port (RS 232)
- for USB-port a USB-to-serial adaptor is needed
- Spare RC module (for use in additional models):
(for HeliCommand with 4-pin socket) No. 8494-4000
(for HeliCommand with 3-pin socket) No. 8494-3000
- containing micro controller
- incl. mounting bracket, hook-and-loop tape, cable ties and foam tape to change *HeliCommand* main unit
- Version update: robbe Service Centres, see robbe catalogue

Service

robbe – Service
Metzloser Strasse 36
36355 GREBENHAIN
Tel.: 0049-6644-87-777
Fax: 0049-6644-7412

Imprint

robbe Modellsport GmbH & Co. KG
Postfach 1108
D-36352 Grebenhain

Internet: www.robbe.com
E-Mail: office@robbe.com
Tel.: 0049 (0) 6644 / 870
Fax: 0049 (0) 6644 / 7412

Notes:

Notes:

